



Inductive sensor NBN4-F25-2Z4L-V1

- Direct mounting on standard actuators
- Small construction with sturdy plastic housing of protection class IP 67
- 2-wire DC sensor with minimum off-state current
- M12 male connector



Dimensions

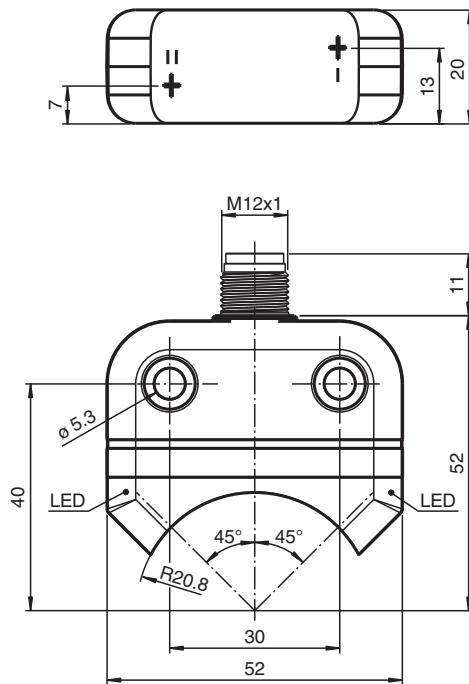

Technical Data

General specifications

Switching function		2 x normally open (NO)
Output type		Two-wire with minimum off-state current
Rated operating distance	s_n	4 mm
Installation		flush mountable
Output polarity		DC
Assured operating distance	s_a	0 ... 3.24 mm
Actual operating distance	s_r	3.6 ... 4.4 mm typ.
Reduction factor r_{AI}		0.6
Reduction factor r_{Cu}		0.45

Release date: 2022-05-23 Date of issue: 2022-05-23 Filename: 264861_eng.pdf

Refer to "General Notes Relating to Pepperl+Fuchs Product Information".

Pepperl+Fuchs Group
www.pepperl-fuchs.com

USA: +1 330 486 0001
fa-info@us.pepperl-fuchs.com

Germany: +49 621 776 1111
fa-info@de.pepperl-fuchs.com

Singapore: +65 6779 9091
fa-info@sg.pepperl-fuchs.com

PF PEPPERL+FUCHS



Technical Data

Reduction factor r_{304}		1
Reduction factor r_{S137}		1.2
Output type		2x 2-wire
Nominal ratings		
Operating voltage	U_B	5 ... 30 V DC
Switching frequency	f	0 ... 500 Hz
Hysteresis	H	typ. 5 %
Reverse polarity protection		reverse polarity protected
Short-circuit protection		pulsing
Voltage drop	U_d	≤ 4.5 V
Operating current	I_L	4 ... 100 mA
Off-state current	I_r	120 ... 200 μ A typ. 175 μ A at 25 °C
Time delay before availability	t_v	≤ 100 ms
Switching state indicator		LED, yellow
Compliance with standards and directives		
Standard conformity		
Standards		EN 60947-5-2:2007 EN 60947-5-2/A1:2012 IEC 60947-5-2:2007 IEC 60947-5-2 AMD 1:2012
Approvals and certificates		
UL approval		cULus Listed
CCC approval		CCC approval / marking not required for products rated ≤ 36 V
Ambient conditions		
Ambient temperature		-25 ... 70 °C (-13 ... 158 °F)
Storage temperature		-40 ... 85 °C (-40 ... 185 °F)
Mechanical specifications		
Connection type		Connector plug M12 x 1 , 4-pin
Connector housing		metal
Housing material		PBT
Sensing face		PC
Degree of protection		IP67
Mass		49 g
Tightening torque, fastening screws		M5 x 25 : 2.7 Nm
Note		Mounted on mechanical drive

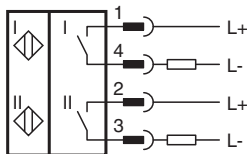

Connection



Accessories

	BT32	Activator for F25 series
	BT33	Activator for F25 series

Accessories

	BT34	Activator for F25 series
	BT32XAS	Activator for F25 series
	BT43-RG-01	Activator for F25 series including protective housing and mounting plate